

IDAHO DEPARTMENT OF LANDS
DIRECTOR'S OFFICE
300 N 6th Street Suite 103
PO Box 83720
Boise ID 83720-0050
Phone (208) 334-0200
Fax (208) 334-5342



MICK THOMAS, DIVISION ADMINISTRATOR
SECRETARY TO THE COMMISSION

IDAHO OIL AND GAS
CONSERVATION COMMISSION
Betty Coppersmith, Chairman
Marc Shigeta, Vice-Chairman
Jim Classen
Renee Love, Ph.D
Dustin T. Miller

February 11, 2020

Snake River Oil & Gas, LLC
Attn: Mr. Chris Weiser
117 East Calhoun
Magnolia, AR 71753-3528

SUBJECT: Conditional Transfer of Well Permits, Well Operations

Dear Mr. Weiser,

This correspondence is notification that the Idaho Department of Lands recognizes the transfer of the well permits listed below from AM Idaho, LLC to Snake River Oil & Gas, LLC. The designation of Snake River Oil & Gas, LLC as the designated operator of the wells only applies to the wells designated below and does not apply to leases administered by Idaho Department of Lands, current applications, or Orders issued by Idaho Department of Lands or the Idaho Oil & Gas Conservation Commission to Alta Mesa Services, LP, or AM Idaho LLC.

The Department of Lands received and accepted your Power of Attorney and Acknowledgment of Surety from RLI Insurance Company in the amount of \$100,000 for the following wells:

No.	API Number	Well Name
1.	11-075-20-020	DJS Properties #1-15
2.	11-075-20-022	ML Investments #2-10
3.	11-075-20-023	DJS Properties #2-14
4.	11-075-20-024	Kauffman #1-34
5.	11-075-20-025	ML Investments #1-11
6.	11-075-20-026	ML Investments #1-3
7.	11-075-20-027	Kauffman #1-9
8.	11-075-20-029	ML Investments #2-3
9.	11-075-20-031	ML Investments #3-10
10.	11-075-20-033	Barlow #1-14
11.	11-075-20-032	Fallon #1-10

The Idaho Department of Lands does not recognize the transfer of operator for the Tracy Trust #3-2 well (USWN 11-075-20011) because it has not received a bond for the required amount of \$100,000 per IDAPA 20.07.02.220.03 and IDAPA 20.07.02.220.04.

By assuming operatorship of the wells listed above, Snake River agrees to assume full responsibility for the operation and eventual abandonment in conformity with the laws, rules, regulations and orders issued by the Commission.

If you have any questions, please don't hesitate to contact me at your earliest convenience.

Sincerely,

A handwritten signature in blue ink that reads "Mick Thomas". The signature is written in a cursive, flowing style.

Mick Thomas
Division Administrator, Oil & Gas
Secretary to the Oil & Gas Commission
(208) 334-0298 Office
Website: <https://ogcc.idaho.gov>
[News](#) | [Facebook](#) | [Twitter](#) | [Web](#)
[Sign up to receive news from IDL](#)

ecc: Chad Rader, Richard Brown, Nathan Caldwell, James Thum

IDAHO DEPARTMENT OF LANDS
DIRECTOR'S OFFICE
300 N 6th Street Suite 103
PO Box 83720
Boise ID 83720-0050
Phone (208) 334-0200
Fax (208) 334-5342



IDAHO OIL AND GAS
CONSERVATION COMMISSION
James Classen
Ken Smith
Margaret Chipman
Chris Beck
Sid Cellan

September 17, 2014

Ronda Louderman
Regulatory Coordinator
15021 Katy Frwy., Suite 400
Houston, TX 77094

SUBJECT: Permit to Drill API#11-075-20027-01, Kauffman 1-9

The Idaho Department of Lands has completed our review of this application for multiple zone completion. Enclosed is a copy of the approved amended permit. This permit was approved with the following stipulations:

1. All well log information required by IDAPA 20.07.02.091 will be submitted to IDL within 30 days of the logs being run.
2. Idaho Department of Lands inspectors shall have 24 hour, unencumbered access for compliance and regulatory purposes.
3. All cementing operations shall be in accordance with IDAPA 20.07.02.050. Cement will be returned to surface on all string via the squeeze method as approved by the Department.
4. This permit does not grant the right for ingress or egress nor does this application grant the right to production from unleased lands.
5. Within 30 days of the conclusion of the completion work, a completion report must be submitted to the Department.

Please ensure that all operations are conducted in accordance with the requirements of IDAPA 20.07.02 (Rules Governing Conservation Of Crude Oil And Natural Gas In The State Of Idaho).

This amended permit will be administered by AJ Mondor in our Southwest Supervisory Area. He will be inspecting the drilling operation. Please contact him at 208-334-3488 if you have any questions.

Sincerely,

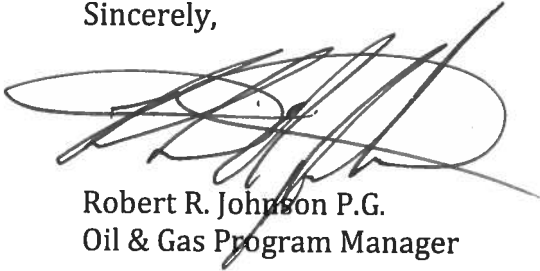
A handwritten signature in black ink, appearing to read 'Robert R. Johnson', written over a circular stamp or seal.

Robert R. Johnson P.G.
Oil & Gas Program Manager

cc: AJ Mondor, Resource Specialist, IDL Southwest Office
Chad Hersley, IDWR, PO Box 83720, Boise, Idaho 83720-0098

\$700.00
Fee

AMENDMENT



IDAHO OIL AND GAS CONSERVATION COMMISSION

Application For Permit to Drill, Deepen or Plug Back DEPT. OF LANDS

APPLICATION TO: Drill (\$2,000) Deepen (\$500) Plug Back (\$500) 2014 SEP 16 PM 2:59

NAME OF COMPANY OR OPERATOR: Alta Mesa Services, LP Date: 09/15/2014
Address: 15021 Katy Frwy., Suite 400
City: Houston State: TX Zip Code: 77094 Telephone: 281-530-0991
Contact Name: Ronda Louderman Email Address: rlouderman@altamesa.net

DESCRIPTION OF WELL AND LEASE

Name of Lease: Kauffman Well Number: 1-9 Elevation (ground) 2,606 feet
Well Location: Section: 9 Township: 8 North Range: 4 West (or block and survey)
(give footage from Section lines): Surface Location-1325' from East Section Line, 190' from North Line, Bottom Hole Location-397' from North Section Line, 931' from East Section Line
Field and Reservoir (if wildcat, so state): Willow County: Payette
Distance, in miles, and direction from nearest town or post office: 5.49 miles East
Nearest distance from proposed location to property or lease line: Surface-50' from West Lease Line, Bottom-397' from North Lease Line feet
Distance from proposed location to nearest drilling, completed or applied for on the same lease: N/A feet
Proposed depth: 5,800' Rotary or cable tools: Rotary
Planned logging tools: Mud Logging only while drilling. After: Gamma Ray, Propagation Resistivity, Density, Neutron Porosity, Electron Capture Spectroscopy; Sonic; and Percussion sidewall cores will be completed by wireline
Approx date work will start: 09/17/2014 Number of acres in lease(s): 640
Number of wells on lease, including this well, completed in or drilling to this reservoir: 1
If lease purchased with one or more wells drilled, complete the following information:
Purchased from (name) N/A
Address of above _____
Status of bond _____

Remarks: (If this is an application to deepen or plug back, briefly describe work to be done, giving present producing zone and expected new producing zone) We will pump 8 cu yds of cement from surface down to below surface pipe and shut in the backside of the production casing. This will enable to have a full column of cement from surface to bottom of surface pipe. We propose to then perform a dual completion by swabbing down to 1000' and perforating; flow test the well; set a packer with burst discs to isolate the bottom of zone; perforate and flow test upper zone; kill well; run long string with dual packer; sling into bottom packer; and set upper dual packer; run short string and tie into dual packer; swab well in and test

CERTIFICATE: I, the undersigned, state that I am the Regulatory Coordinator
of Alta Mesa Services, LP (company) and that I am authorized by said company to make this application and that this application was prepared under my supervision and direction and that the facts stated herein are true, correct and complete to the best of my knowledge.

Date: 9-16-2014 Signature: Ronda Louderman

Permit Number: _____ Approval Date: _____ Approved by: _____
API Number: 11-075-20027-01

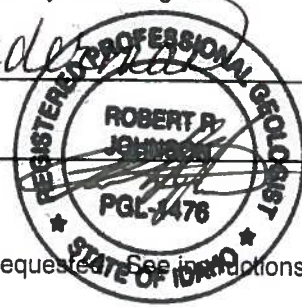

NOTICE: Before sending in this form, be sure that you have given all information requested. See instructions on back.

AFFIDAVIT

I, Dale Hayes, make the following statement and declare this as true to the best of my information, knowledge, and belief.

In regards to Alta Mesa Services LP's operations in Payette County, Idaho, there are no offset operators to drilling locations for the Kauffman 1-9; ML Investments 2-10; and the ML Investments 1-11.

AMS is currently requesting an amendment to the original drilling permits submitted to Idaho Department of Lands. This amendment will notify the Department of proposed dual completions for each well and therefore, request a waiver of the 15 day comment period for such amendment as required by IDAPA 220.01 when offset operators are present.

Dale Hayes

Dale Hayes, VP of Operations
Alta Mesa Services, LP

SUBSCRIBED AND SWORN to me on
this day September 16, 2014.

Melinda Frew

Notary Public
My Commission Expires: 11-5-2014



DEPT. OF LANDS
2014 SEP 16 PM 2:59
BOISE, IDAHO

© 2014 T-O ENGINEERS. THIS INSTRUMENT IS THE PROPERTY OF T-O ENGINEERS. ANY REPRODUCTION, REUSE OR MODIFICATION OF THIS INSTRUMENT OR ITS CONTENTS WITHOUT SPECIFIC WRITTEN PERMISSION OF T-O ENGINEERS IS STRICTLY PROHIBITED.

MASS GRADING EXHIBIT MAP OF SECTION 9

LOCATED IN A PORTION OF SECTION 9
TOWNSHIP 8 NORTH, RANGE 4 WEST, BOISE MERIDIAN
PAYETTE COUNTY, IDAHO
2014

Volume Cut:	4,600 CY
Volume Fill:	4,300 CY

Range Details

Scale scheme to fit

ID	Minimum Elevation	Maximum Elevation	Color Scheme
1	-10.166'	-3.303'	
2	-3.303'	0.000'	
3	0.000'	0.008'	
4	0.008'	1.209'	
5	1.209'	2.607'	
6	2.607'	7.362'	
7	7.362'	13.814'	

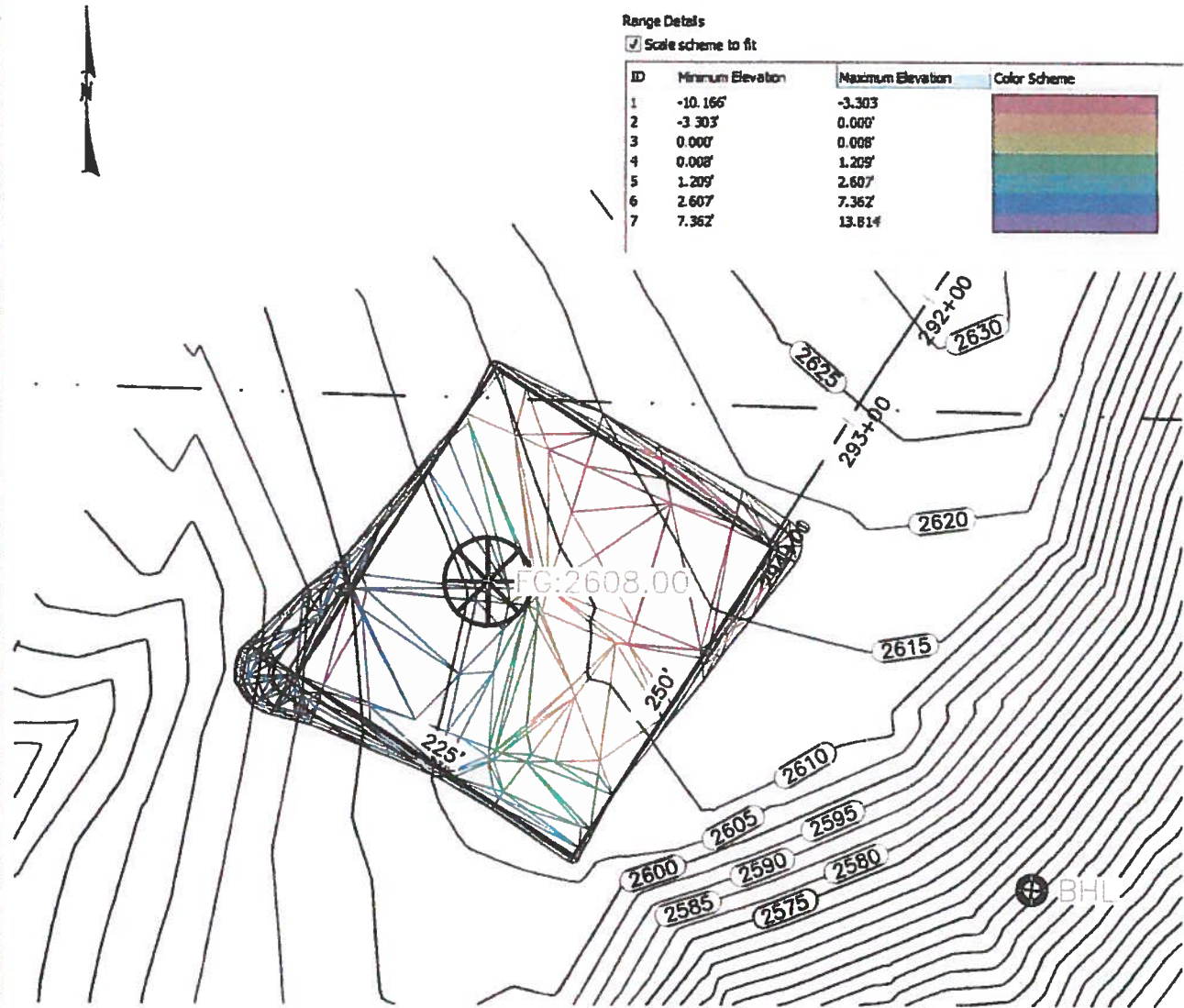

9777 CHINDEN BOULEVARD
BOISE, IDAHO 83714-2008

PHONE: (208) 323-2288 FAX: (208) 323-2399
E-FILE:130216-C-SEC9WeKFile.dwg DATE MAY 2014 JOB: 130216

**Alta Mesa
Kaufman 1-9
Payette Co., Idaho
Proposed Surface Squeeze**

GL: 2,606'

RKB: 14' (2,620')

All depths reference RKB unless otherwise noted.

Conductor

13-3/8" 54.5 K-55 LTC @ 134'
Redlmix cement

Surface Casing

9-5/8" 40 ppf K-55 LTC @ 1,126'MD
Hole Size: 12-1/4"
Lead: 134 sxs (90 bbls) type III cement + ad.
3.65 ft3/sk 14.22 gal/sk 10.4 ppg
Tail: 70 sxs (17 bbls) type III cement + ad.
1.36 ft3/sk 6.42 gal/sk 14.8 ppg
Top Job: 70 sxs (15 bbls) Calprem cement + ad.
1.15 ft3/sk 5 gal/sk 15.8 ppg
Top Job 2: 50 sxs (14 bbls) Calprem cement + ad.
1.82 ft3/sk 9.72 gal/sk 13.2 ppg
Cemented to surface
MW 8.8 ppg WBM
FIT = 10 ppg EMW

**Squeeze 7" x 9-5/8" annulus
with ~35 bbls of cement
(annular volume = 31.8 bbls)**

Production Casing

7" 26ppf J-55 BTC @ 5,010'
Hole Size: 8-3/4"
Lead: 367 sxs (119 bbls) Class G cement + Ad
1.82 ft3/sx 9.72 gal/sk 12.7 ppg
Tail: 311 sxs (64bbls) Class G cement + ad.
1.16 ft3/sk 4.9 gal/sk 16 ppg
MW @ TD 9.8 ppg OBM
Did not cement to surface

Cement plug from 5,060 - 5,400'

WBM

Total Depth: 5,687' TVD/5,755'MD

Well Name & No.: Kaufman 1-9	Field: Wildcat
County or Parish: Payette	State: Idaho
Total Depth (MD): 5,755'	(TVD): 5,687'

**Alta Mesa
Kaufman 1-9
Payette Co., Idaho
Proposed Surface Squeeze**

GL: 2,606'

RKB: 14' (2,620')

All depths reference RKB unless otherwise noted.

Conductor

13-3/8" 54.5 K-55 LTC @ 134'
Redimix cement

Surface Casing

9-5/8" 40 ppf K-55 LTC @ 1,126'MD
Hole Size: 12-1/4"

Lead: 134 sxs (90 bbls) type III cement + ad.
3.65 ft³/sk 14.22 gal/sk 10.4 ppg

Tail: 70 sxs (17 bbls) type III cement + ad.
1.36 ft³/sk 6.42 gal/sk 14.8 ppg

Top Job: 70 sxs (15 bbls) Calprem cement + ad.
1.15 ft³/sk 5 gal/sk 15.8 ppg

Top Job 2: 50 sxs (14 bbls) Calprem cement + ad.
1.82 ft³/sk 9.72 gal/sk 13.2 ppg

Cemented to surface

MW 8.8 ppg WBM
FIT = 10 ppg EMW

**Squeeze 7" x 9-5/8" annulus
with ~35 bbls of cement
(annular volume = 31.8 bbls)**

Production Casing

7" 26ppf J-55 BTC @ 5,010

Hole Size: 8-3/4"

Lead: 367 sxs (119 bbls) Class G cement +. Ad
1.82 ft³/sk 9.72 gal/sk 12.7 ppg

Tail: 311 sxs (64bbls) Class G cement + ad.
1.16 ft³/sk 4.9 gal/sk 16 ppg

MW @ TD 9.8 ppg OBM

Did not cement to surface

Cement plug from 5,060 - 5,400'

WBM

Total Depth: 5,687' TVD/5,755'MD

Well Name & No.: Kaufman 1-9	Field: Wildcat
County or Parish: Payette	State: Idaho
Total Depth (MD): 5,755'	(TVD): 5,687'

IDAHO DEPARTMENT OF LANDS
DIRECTOR'S OFFICE
300 N 6th Street Suite 103
PO Box 83720
Boise ID 83720-0050
Phone (208) 334-0200
Fax (208) 334-5342



IDAHO OIL AND GAS
CONSERVATION COMMISSION
James Classen
Ken Smith
Margaret Chipman
Chris Beck
Sid Cellan

June 24, 2014

Ronda Louderman
Regulatory Coordinator
15021 Katy Frwy., Suite 400
Houston, TX 77094

SUBJECT: Permit to Drill API#11-075-20027, Kauffman 1-9

The Idaho Department of Lands has completed our review of this permit to drill for oil. Enclosed is a copy of the approved permit. This permit was approved with the following stipulations:

1. The permittee shall be required to submit an affidavit covering the initial BOP pressure test after installation signed by the operator or contractor attesting to the satisfactory pressure test.
2. The permittee shall ensure tanks are adequately sized, designed and constructed for the reception and confinement of mud and cuttings and to prevent contamination of streams and potable water.
3. Drilled holes cannot be used for any other purposes unless they are constructed according to the applicable well construction standards administered by the Idaho Department of Water Resources.
4. Applicant will obtain any needed water rights from Idaho Department of Water Resources if nearby wells will be used to supply water for the drilling operations.
5. All well log information required by IDAPA 20.07.02.091 will be submitted to IDL within 30 days of the logs being run.
6. Idaho Department of Lands inspectors shall have 24 hour, unencumbered access for compliance and regulatory purposes.
7. All cementing operations shall be in accordance with IDAPA 20.07.02.050. Cement will be returned to surface on all string via the

pump and plug method or other method as approved by the Department.

8. This permit does not grant the right for ingress or egress nor does this application grant the right to production from unleased lands.
9. No production or drainage must occur until all circumstance in item 8 above has been met or the Commission has issued an order to satisfy item 8.

Please ensure that all operations are conducted in accordance with the requirements of IDAPA 20.07.02 (Rules Governing Conservation Of Crude Oil And Natural Gas In The State Of Idaho).

This permit will be administered by AJ Mondor in our Southwest Supervisory Area. He will be inspecting the drilling operation. Please contact him at 208-334-3488 if you have any questions.

Sincerely,

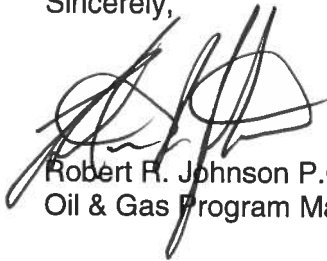
A handwritten signature in black ink, appearing to be 'R. Johnson', written over a printed name and title.

Robert R. Johnson P.G.
Oil & Gas Program Manager

cc: AJ Mondor, Resource Specialist, IDL Southwest Office
Chad Hersley, IDWR, PO Box 83720, Boise, Idaho 83720-0098



IDAHO OIL AND GAS CONSERVATION COMMISSION

Application For Permit to Drill, Deepen or Plug Back

APPLICATION TO: Drill (\$2,000) [X] Deepen (\$500) [] Plug Back (\$500) []

NAME OF COMPANY OR OPERATOR: Alta Mesa Services, LP Date: 05-23-14

Address: 15021 Katy Frwy., Suite 400

City: Houston State: TX Zip Code: 77094 Telephone: 713-530-0991

Contact Name: Ronda Louderman Email Address: rlouderman@altamesa.net

2014 MAY 23 AM 8:04 DEPT. OF LANDS Boise, IDAHO

DESCRIPTION OF WELL AND LEASE

Name of Lease: Kauffman Well Number: 1-9 Elevation (ground) 2,606 feet

Well Location: Section: 9 Township: 8 North Range: 4 West (or block and survey)

(give footage from Section lines): Surface Location - 1325' from East Section line, 190' from North Section

Line, Bottom Hole Location - 397' from North Section line, 931' from East Section line

Field and Reservoir (if wildcat, so state): Willow County: Payette

Distance, in miles, and direction from nearest town or post office: 5.49 miles East

Nearest distance from proposed location to property or lease line: Surface - 50' from West Lease Line; Bottom - 397' from North Lease line Distance from proposed location to nearest drilling, completed or applied for on the same lease: N/A

Proposed depth: 5,800' Rotary or cable tools: Rotary

Planned logging tools Mud Logging only while drilling. After: Gamma Ray; Propagation Resistivity; Density, Neutron Porosity, Electron Capture Spectroscopy; Sonic; and Percussion sidewall cores will be completed by wireline.

Approx date work will start: June 20, 2014 Number of acres in lease(s): 640

Number of wells on lease, including this well, completed in or drilling to this reservoir: 1

If lease purchased with one or more wells drilled, complete the following information:

Purchased from (name) N/A

Address of above

Status of bond

Remarks: (If this is an application to deepen or plug back, briefly describe work to be done, giving present producing zone and expected new producing zone) N/A

CERTIFICATE: I, the undersigned, state that I am the Regulatory Coordinator of Alta Mesa Services, LP

(company) and that I am authorized by said company to make this application and that this application was prepared under my supervision and direction and that the facts stated herein are true, correct and complete to the best of my knowledge.

Date: 5-23-14 Signature: Ronda Louderman

Permit Number: Approval Date: 6/4/14 Approved by: ROBERT R JOHNSON

API Number: 11-075-20027

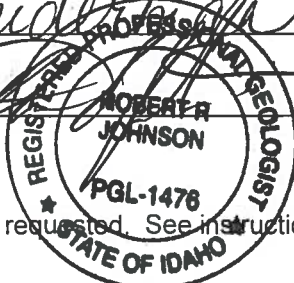

NOTICE: Before sending in this form, be sure that you have given all information requested. See instructions on back.

LOCATION EXHIBIT MAP OF SECTION 9

LOCATED IN A PORTION OF SECTION 9
TOWNSHIP 8 NORTH, RANGE 4 WEST, BOISE MERIDIAN
PAYETTE COUNTY, IDAHO
2014

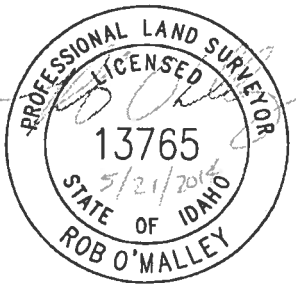
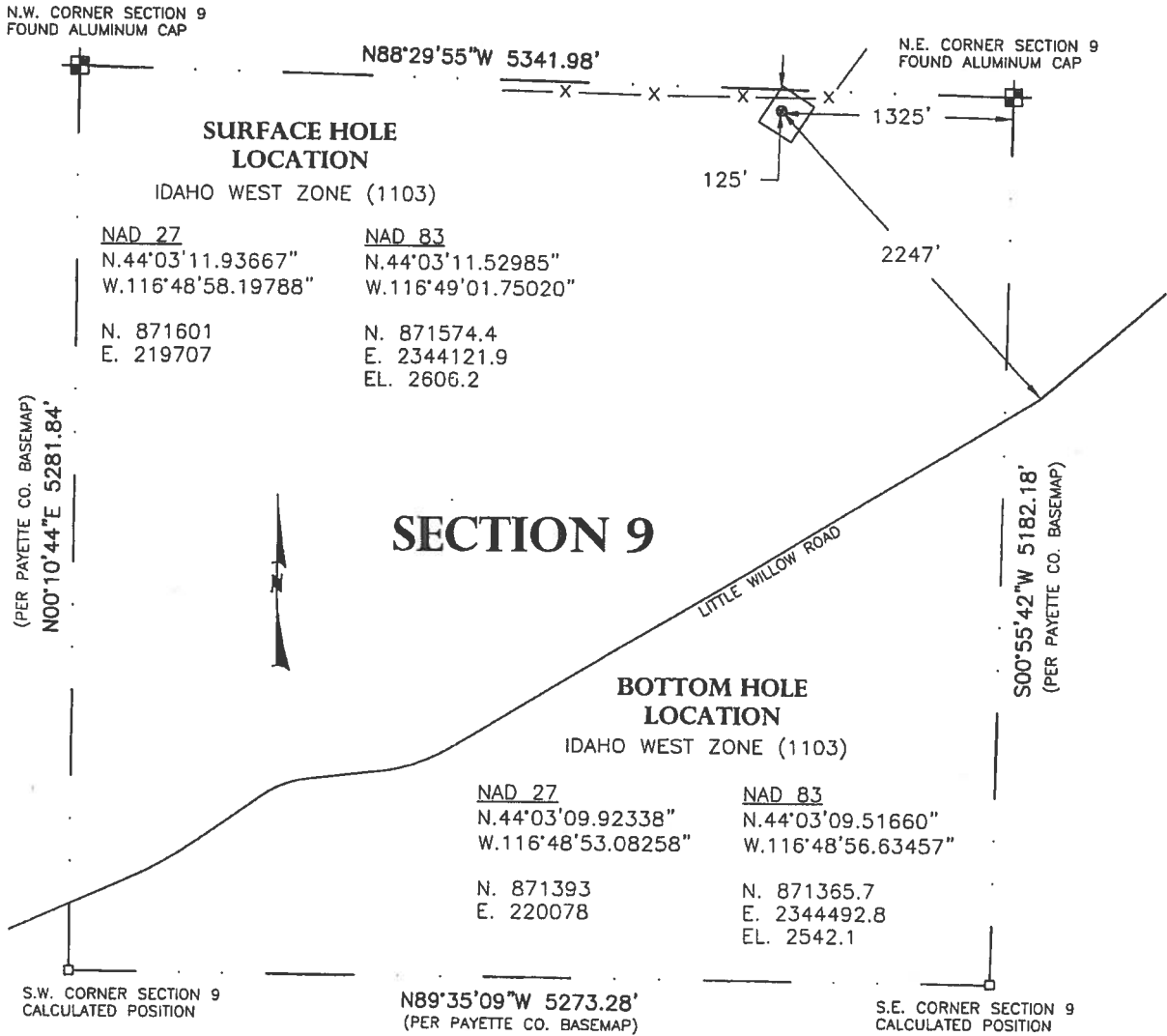

T-O ENGINEERS

9777 CHINDEN BOULEVARD
BOISE, IDAHO 83714-2008

PHONE: (208) 323-2288 FAX: (208) 323-2399

E-FILE: H:\130216-BO\Acoding\Survey DATE: 21-May-14 JOB: 130216



ALTA MESA

ALTA MESA
 Field: Payette County, ID
 Site: Kauffman 1-9
 Well: #1-9
 Wellpath: Original Hole
 Plan: Plan #2



Precision
 Directional Services

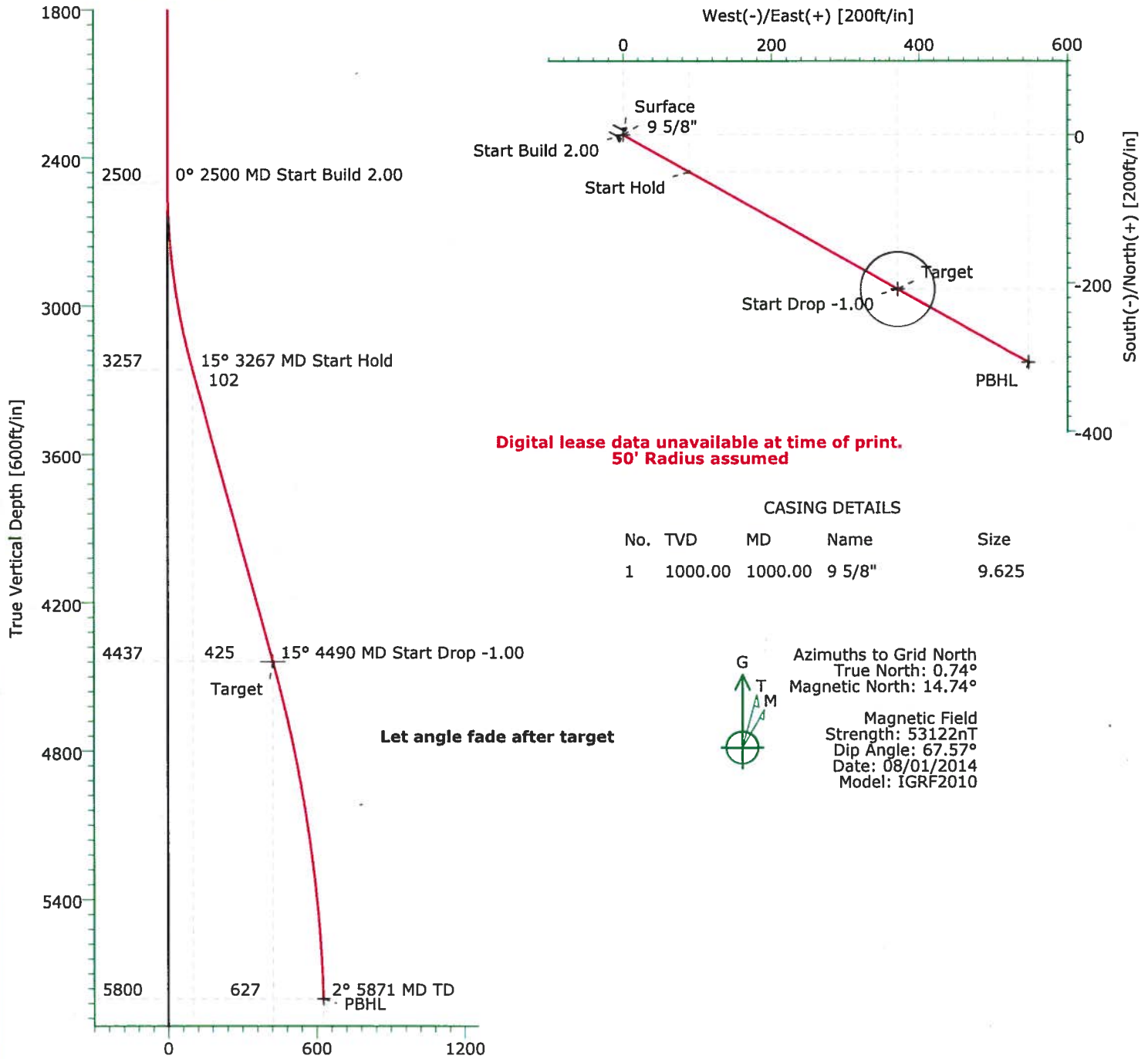

Digital lease data unavailable at time of print.
 50' Radius assumed

CASING DETAILS

No.	TVD	MD	Name	Size
1	1000.00	1000.00	9 5/8"	9.625



Azimuths to Grid North
 True North: 0.74°
 Magnetic North: 14.74°
 Magnetic Field
 Strength: 53122nT
 Dip Angle: 67.57°
 Date: 08/01/2014
 Model: IGRF2010

Let angle fade after target

Vertical Section at 119.28° [600ft/in]

TARGET DETAILS

Name	TVD	+N/-S	+E/-W	Northing	Easting	Latitude	Longitude	Shape
Surface	0.00	0.00	0.00	871601.00	219707.00	44°03'11.930N	16°48'58.199W	Point
Target	4437.00	-208.00	371.00	871393.00	220078.00	44°03'09.923N	16°48'53.083W	Circle (Radius: 50)
PBHL	5800.00	-306.73	547.10	871294.27	220254.10	44°03'08.971N	16°48'50.654W	Point

SECTION DETAILS

Sec	MD	Inc	Azi	TVD	+N/-S	+E/-W	DLeg	TFace	VSec	Target
1	0.00	0.00	119.28	0.00	0.00	0.00	0.00	0.00	0.00	
2	2500.00	0.00	119.28	2500.00	0.00	0.00	0.00	0.00	0.00	
3	3266.56	15.33	119.28	3257.45	-49.86	88.93	2.00	119.28	101.95	
4	4489.64	15.33	119.28	4437.00	-208.00	371.00	0.00	0.00	425.33	Target
5	5870.85	1.52	119.28	5800.00	-306.73	547.10	1.00	180.00	627.21	PBHL

Precision Directional Services, Inc.

Planning Report

Company: ALTA MESA	Date: 05/22/2014	Time: 11:35:07	Page: 1
Field: Payette County, ID	Co-ordinate(NE) Reference: Well: #1-9, Grid North		
Site: Kauffman 1-9	Vertical (TVD) Reference: 2606'GL+12'KB 2618.0		
Well: #1-9	Section (VS) Reference: Well (0.00N,0.00E,119.28Azi)		
Wellpath: Original Hole	Plan: Plan #2		

Field: Payette County, ID			
Map System: US State Plane Coordinate System 1927		Map Zone: Idaho, Western Zone	
Geo Datum: NAD27 (Clarke 1866)		Coordinate System: Well Centre	
Sys Datum: Mean Sea Level		Geomagnetic Model: IGRF2010	

Site: Kauffman 1-9			
Section 9 T8N-R4W			
Site Position:	Northing: 871601.00 ft	Latitude: 44 3 11.930 N	
From: Map	Easting: 219707.00 ft	Longitude: 116 48 58.199 W	
Position Uncertainty: 0.00 ft		North Reference: Grid	
Ground Level: 2606.00 ft		Grid Convergence: -0.74 deg	

Well: #1-9		Slot Name:	
Well Position:	+N-S 0.00 ft	Northing: 871601.00 ft	Latitude: 44 3 11.930 N
	+E-W 0.00 ft	Easting: 219707.00 ft	Longitude: 116 48 58.199 W
Position Uncertainty: 0.00 ft			

Wellpath: Original Hole		Drilled From: Surface	
Current Datum: 2606'GL+12'KB	Height 2618.00 ft	Tie-on Depth: 0.00 ft	
Magnetic Data: 08/01/2014		Above System Datum: Mean Sea Level	
Field Strength: 53122 nT		Declination: 14.00 deg	
Vertical Section:	Depth From (TVD)	Mag Dip Angle: 67.57 deg	
	ft	+N-S	Direction
		ft	deg
	0.00	0.00	119.28
		0.00	
		0.00	

Plan: Plan #2	Date Composed: 05/21/2014
p2 for datum conversion	Version: 1
Principal: No	Tied-to: From Surface

Plan Section Information

MD ft	Incl deg	Azim deg	TVD ft	+N-S ft	+E-W ft	DLS deg/100ft	Build deg/100ft	Turn deg/100ft	TFO deg	Target
0.00	0.00	119.28	0.00	0.00	0.00	0.00	0.00	0.00	0.00	
2500.00	0.00	119.28	2500.00	0.00	0.00	0.00	0.00	0.00	0.00	
3266.56	15.33	119.28	3257.45	-49.86	88.93	2.00	2.00	0.00	119.28	
4489.64	15.33	119.28	4437.00	-208.00	371.00	0.00	0.00	0.00	0.00	Target
5870.85	1.52	119.28	5800.00	-306.73	547.10	1.00	-1.00	0.00	180.00	PBHL

Survey

MD ft	Incl deg	Azim deg	TVD ft	+N-S ft	+E-W ft	VS ft	DLS deg/100ft	Build deg/100ft	Turn deg/100ft	Tool/Comment
2500.00	0.00	119.28	2500.00	0.00	0.00	0.00	0.00	0.00	0.00	
2600.00	2.00	119.28	2599.98	-0.85	1.52	1.75	2.00	2.00	0.00	
2700.00	4.00	119.28	2699.84	-3.41	6.09	6.98	2.00	2.00	0.00	
2800.00	6.00	119.28	2799.45	-7.67	13.69	15.69	2.00	2.00	0.00	
2900.00	8.00	119.28	2898.70	-13.63	24.32	27.88	2.00	2.00	0.00	
3000.00	10.00	119.28	2997.47	-21.28	37.96	43.52	2.00	2.00	0.00	
3100.00	12.00	119.28	3095.62	-30.61	54.61	62.60	2.00	2.00	0.00	
3200.00	14.00	119.28	3193.06	-41.61	74.23	85.10	2.00	2.00	0.00	
3266.56	15.33	119.28	3257.45	-49.86	88.93	101.95	2.00	2.00	0.00	
3300.00	15.33	119.28	3289.70	-54.18	96.64	110.79	0.00	0.00	0.00	
3400.00	15.33	119.28	3386.14	-67.11	119.70	137.23	0.00	0.00	0.00	
3500.00	15.33	119.28	3482.58	-80.04	142.76	163.67	0.00	0.00	0.00	
3600.00	15.33	119.28	3579.02	-92.97	165.83	190.11	0.00	0.00	0.00	
3700.00	15.33	119.28	3675.46	-105.90	188.89	216.55	0.00	0.00	0.00	
3800.00	15.33	119.28	3771.90	-118.83	211.95	242.99	0.00	0.00	0.00	
3900.00	15.33	119.28	3868.34	-131.76	235.01	269.43	0.00	0.00	0.00	

Precision Directional Services, Inc.

Planning Report

Company: ALTA MESA	Date: 05/22/2014	Time: 11:35:07	Page: 2
Field: Payette County, ID	Co-ordinate(NE) Reference: Well: #1-9, Grid North		
Site: Kauffman 1-9	Vertical (TVD) Reference: 2606'GL+12'KB 2618.0		
Well: #1-9	Section (VS) Reference: Well (0.00N,0.00E,119.28Azi)		
Wellpath: Original Hole	Plan: Plan #2		

Survey

MD ft	Incl deg	Azim deg	TVD ft	+N/-S ft	+E/-W ft	VS ft	DLS deg/100ft	Build deg/100ft	Turn deg/100ft	Tool/Comment
4000.00	15.33	119.28	3964.78	-144.69	258.08	295.87	0.00	0.00	0.00	
4100.00	15.33	119.28	4061.23	-157.62	281.14	322.31	0.00	0.00	0.00	
4200.00	15.33	119.28	4157.67	-170.55	304.20	348.75	0.00	0.00	0.00	
4300.00	15.33	119.28	4254.11	-183.48	327.26	375.19	0.00	0.00	0.00	
4400.00	15.33	119.28	4350.55	-196.41	350.33	401.63	0.00	0.00	0.00	
4489.64	15.33	119.28	4437.00	-208.00	371.00	425.33	0.00	0.00	0.00	Target
4500.00	15.23	119.28	4446.99	-209.34	373.38	428.06	1.00	-1.00	0.00	
4600.00	14.23	119.28	4543.71	-221.77	395.56	453.48	1.00	-1.00	0.00	
4700.00	13.23	119.28	4640.85	-233.37	416.26	477.21	1.00	-1.00	0.00	
4800.00	12.23	119.28	4738.39	-244.15	435.47	499.24	1.00	-1.00	0.00	
4900.00	11.23	119.28	4836.30	-254.09	453.20	519.57	1.00	-1.00	0.00	
5000.00	10.23	119.28	4934.55	-263.19	469.44	538.18	1.00	-1.00	0.00	
5100.00	9.23	119.28	5033.11	-271.45	484.18	555.08	1.00	-1.00	0.00	
5200.00	8.23	119.28	5131.95	-278.87	497.41	570.25	1.00	-1.00	0.00	
5300.00	7.23	119.28	5231.05	-285.45	509.14	583.70	1.00	-1.00	0.00	
5400.00	6.23	119.28	5330.36	-291.18	519.36	595.41	1.00	-1.00	0.00	
5500.00	5.23	119.28	5429.85	-296.06	528.06	605.39	1.00	-1.00	0.00	
5600.00	4.23	119.28	5529.51	-300.09	535.25	613.64	1.00	-1.00	0.00	
5700.00	3.23	119.28	5629.30	-303.27	540.92	620.14	1.00	-1.00	0.00	
5800.00	2.23	119.28	5729.19	-305.59	545.08	624.90	1.00	-1.00	0.00	
5870.85	1.52	119.28	5800.00	-306.73	547.10	627.21	1.00	-1.00	0.00	PBHL

Targets

Name	Description		TVD ft	+N/-S ft	+E/-W ft	Map Northing ft	Map Easting ft	<---- Latitude ---->			<--- Longitude --->				
	Dip.	Dir.						Deg	Min	Sec	Deg	Min	Sec		
Surface			0.00	0.00	0.00	871601.00	219707.00	44	3	11.930	N	116	48	58.199	W
Target			4437.00	-208.00	371.00	871393.00	220078.00	44	3	9.923	N	116	48	53.083	W
-Circle (Radius: 50)															
-Plan hit target															
PBHL			5800.00	-306.73	547.10	871294.27	220254.10	44	3	8.971	N	116	48	50.654	W
-Plan hit target															

Casing Points

MD ft	TVD ft	Diameter in	Hole Size in	Name
1000.00	1000.00	9.625	12.250	9 5/8"

© 2014, T-O ENGINEERS. THIS INSTRUMENT IS THE PROPERTY OF T-O ENGINEERS. ANY REPRODUCTION, REUSE OR MODIFICATION OF THIS INSTRUMENT OR ITS CONTENTS WITHOUT SPECIFIC WRITTEN PERMISSION OF T-O ENGINEERS IS STRICTLY PROHIBITED.

MASS GRADING EXHIBIT MAP OF SECTION 9

LOCATED IN A PORTION OF SECTION 9
TOWNSHIP 8 NORTH, RANGE 4 WEST, BOISE MERIDIAN
PAYETTE COUNTY, IDAHO
2014

VOLUME TABLE

Volume Cut: 4,600 CY
Volume Fill: 4,300 CY

Range Details

Scale scheme to fit

ID	Minimum Elevation	Maximum Elevation	Color Scheme
1	-10.166'	-3.303'	
2	-3.303'	0.000'	
3	0.000'	0.008'	
4	0.008'	1.209'	
5	1.209'	2.607'	
6	2.607'	7.362'	
7	7.362'	13.814'	

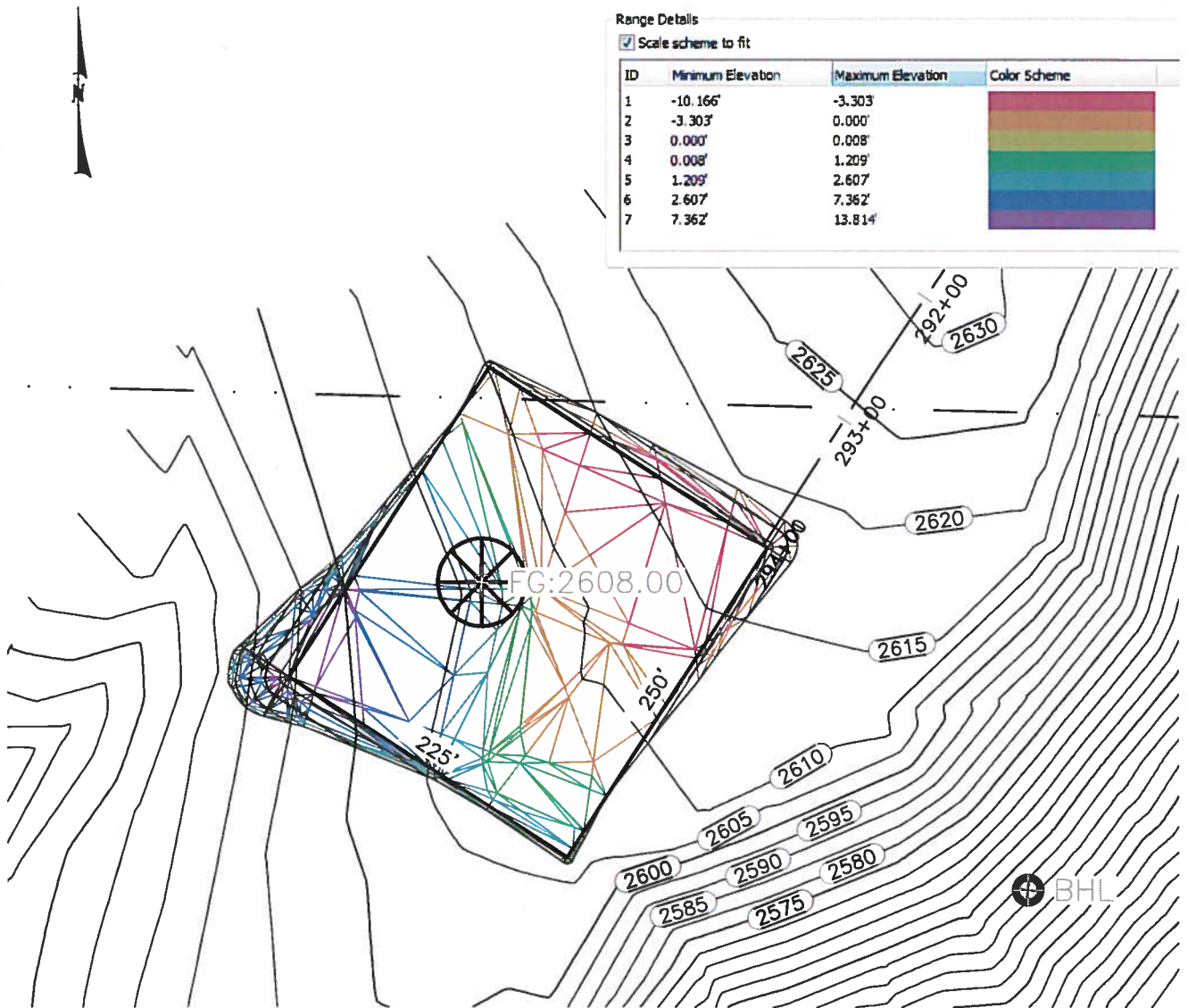

T-O ENGINEERS

9777 CHINDEN BOULEVARD
BOISE, IDAHO 83714-2008

PHONE: (208) 323-2288

FAX: (208) 323-2399

E-FILE: 130216-C-SEC9WellSite.dwg

DATE MAY 2014 JOB: 130216

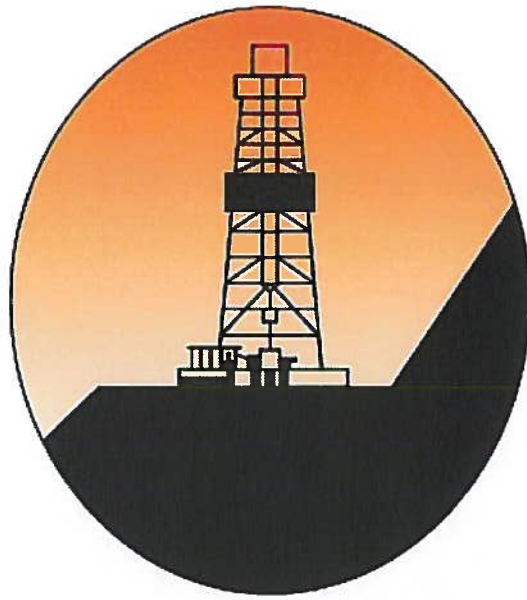

ALTA MESA

ALTA MESA SERVICES, LP

IDL Permit Supplement

Kaufman 1-9

Payette County, ID

May 22, 2014

1	Background Information.....	3
2	Geologic Prognosis.....	4
2.1	Prospect.....	4
2.2	Proposed Well:.....	4
2.3	Estimated Geological Formation Tops.....	4
3	Site Preparation.....	5
3.1	Access Roads.....	5
3.2	Erosion Control.....	5
3.3	Cellars.....	5
3.4	Pit System.....	5
3.5	Sump.....	5
4	Well Construction.....	6
4.1	Casing and Cementing Program.....	6
4.2	Proposed Wellbore Schematic.....	7
4.3	Blow-Out Preventers.....	8
4.4	13-3/8" Conductor.....	9
4.5	12-1/4" Surface Hole.....	9
4.6	8-3/4" Production Hole.....	10
5	Completion.....	12
6	Wellhead.....	13
6.1	Surface Wellhead System.....	13
6.2	Complete Wellhead System with Tree.....	14
7	Reclamation.....	15

1 Background Information

Objective: The objective of this operation is to drill a vertical well to 5,800'TVD/5,871'MD.

AFE #:	TBD	County:	Payette
Well Type:	Vertical	State:	Idaho
Well Name:	Kaufman 1-9	Section:	9
Field:	Willow	Township:	8N
		Range:	4W

Mapping Reference:

System:	NAD83 / NAD27	Mag Dec:	14.15° (01-Jul-2013)
Zone:	UTM11	Grid Conv.:	-0.75113 °
SPCS:	Idaho West Zone 1103	Total Corr.:	14.90113°

Coordinates:

Surface Location:

NAD83

Lat.: N 44° 03' 11.52985"
Long.: W 116° 49' 01.75020"
SPCS: 2344121.9 ft. E
871574.4 ft. N

NAD27

SPCS: 219707 ft. E
871601 ft. N

Bottom Hole Location:

NAD83

Lat.: 44° 03' 09.51660"
Long.: 116° 48' 56.63457"
SPCS: 2344492.8 ft. E
871365.7 W

NAD27

SPCS: 220078 ft. E
871393 ft. N

Elevation:

GL: 2,606 ft.
RKB: 2,618 ft.

Planned TD:

MD: 5,871.0 ft.
TVD: 5,800.0 ft.

Contractor: Paul Graham Drilling

Rig: #7

2 Geologic Prognosis

2.1 Prospect

The Kauffman 1-9 Prospect is designed to test the Willow sand, which is found in the Bridge ML Investments 1-10 Well at 4,088' TVD. It is estimated that the target sand will be encountered at +/-4,452' TVD in the Prospect.

2.2 PROPOSED WELL:

The well is to be directionally drilled to a measured depth of 5,800' TVD/ 5,871'MD. The surface location is in Section 9-8N-4W (Payette County, Idaho).

2.3 Estimated Geological Formation Tops

		Est. Tops are +/-10'		
		Alta Mesa	Alta Mesa	Alta Mesa
		Section 9	Section 9	Section 9
Formation Tops	Comments	Est. MD	Est. TVD	Est. SS
Hamilton Sand		1,483	1,483	1,135
CS Marker 1		1,893	1,893	725
CS Marker 2 (LS Top)		2,638	2,638	-20
CS Marker 3		3,214	3,207	-589
MF		/	/	-1,505
Willow Sand	TARGET	4,506	4,452	-1,834
Top Basalt		/	/	/

3 Site Preparation

3.1 Access Roads

The proposed surface location is to be accessed by an existing farm road that supports heavy truck traffic, approximately 1 mile of improved road over an existing farm path, and 120' of new roadway.

3.2 Erosion Control

Appropriate grading, mechanical stabilization (rip-rap or hay bales), chemical stabilization (soil cement), and silt fencing will be used to prevent soil erosion. All cut and fill slopes are designed with a minimum 2:1 grade to minimize runoff erosion and ensure mechanical stability. See attached engineering drawings.

3.3 Cellars

An 8' deep round cellar box will be installed after the conductor is installed per the relevant section below.

3.4 Pit System

A closed-loop circulating system will be used for this well from spud. Zero discharge practices will be implemented, and all cuttings and waste fluid will be solidified and disposed of at an approved facility. A third party oilfield waste management contractor will provide waste management and tracking services.

3.5 Sump

The location will have a 2' deep trench on downhill sides where the spoil from that trench will be used to construct an earthen berm around the location. The trench will act as a sump to collect rain and wash water for controlled release or appropriate disposal as required.

4 Well Construction

4.1 Casing and Cementing Program

Well Interval	Bit Size	Casing Size, Grade and Weight	Casing Setting Depth	Top of Cement	Cement Type and Volume
Conductor	17-1/2"	13-3/8" 54.5 ppf K-55 LTC	120'	Surface	Class "A" ~140 sxs 100% excess
Surface	12-1/4"	9-5/8" 40 ppf K-55 LTC	1,000'	Surface	Lead: 100 sxs TCI Beaded Lite @ 10.4 ppg, 100% excess Tail: 50 sxs Class "H" @ 14.8 ppg
Production	8-3/4"	5-1/2" 17 ppf K-55 LTC	5,500'	Surface	Lead: 500 sxs TCI Lite @ 12.7 ppg Tail: 200 sxs Gas Seal @ 16.0 ppg

TCI Beaded Lite: An engineered light weight slurry with excellent compressive strength development the slurry exhibits low fluid loss, thixotropic behavior, and has zero free water.

TCI-Lite: A light weight gel extended slurry that develops excellent compressive strength within 24 hours.

Gas-Seal: A premium production casing slurry that has a gas migration control additive for providing an exceptional cement bond to formation and casing. The slurry also contains clay control with low fluid loss for added gas migration inhibition and slurry stability.

4.2 Proposed Wellbore Schematic

**Alta Mesa
 Kaufman 1-9
 Payette Co., Idaho**
Proposed Wellbore Schematic

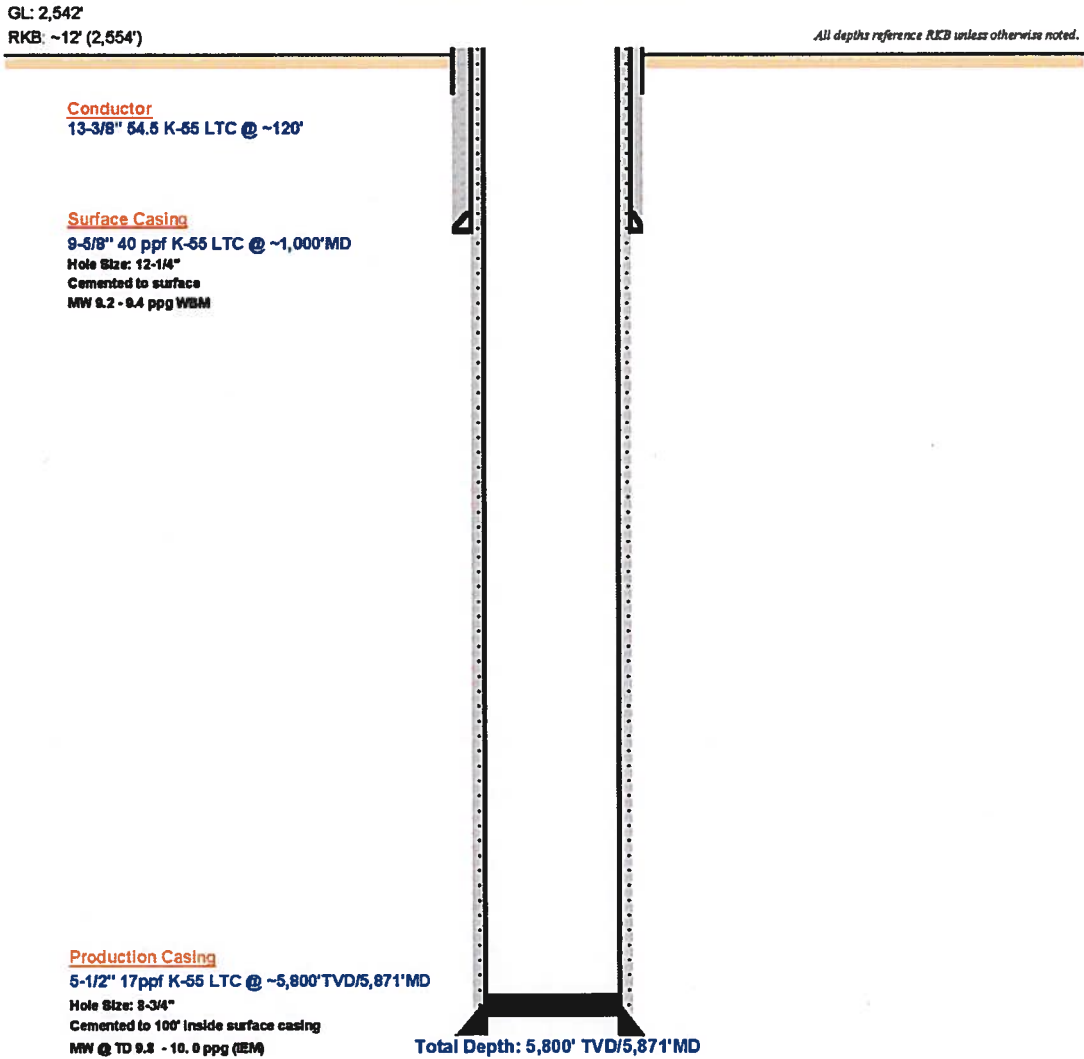

Well Name & No.: Kaufman 1-9	Field: Wildcat
County or Parish: Payette	State: Idaho
Total Depth (MD): 5,871'	(TVD): 5,800'

4.3 Blow-Out Preventers

4.3.1 BOP Hardware Configuration

BOP Stack configuration includes an annular preventer and double ram preventers. The top most ram preventer will be fitted with variable ram blocks, the lower ram preventer will be fitted with blind ram blocks. A full-opening safety valve, inside BOP, and functioning wrench – *specific to the pipe in use and only those specific to the pipe in use* – are to be kept on the rig floor with easy access at all times.

4.3.2 BOP Testing

Test annular, rams, choke manifold, FOSV, and IBOP when BOP is first nipped up on casing head. Low-pressure test to 250psi and high-pressure test to 3,000psi (100% of 3M wellhead), except for annular. Test annular preventer to 2,100psi (70% of 3,000psi rating). Test the kelly hose and standpipe back to pump isolation valves to 200 psi above pop off setting or minimum of 3,000 psi. All tests must hold for five minutes. Retest specific component each time a seal is broken. Work BOP's and flush choke lines each trip. Tighten BOP and wellhead bolts every 3 days. Non-ported float valves to be used in BHA after surface casing set.

During drilling and completion operations, the ram-type blow-out preventer shall be function tested by closing on the drill pipe once every seven (7) days. Independently powered accumulators or accumulators and pumps shall maintain a pressure capacity reserve at all times to provide for repeated operation of hydraulic preventers. All tests may be conducted using a test plug. Tests shall be recorded by charts, if required by the Supervisor.

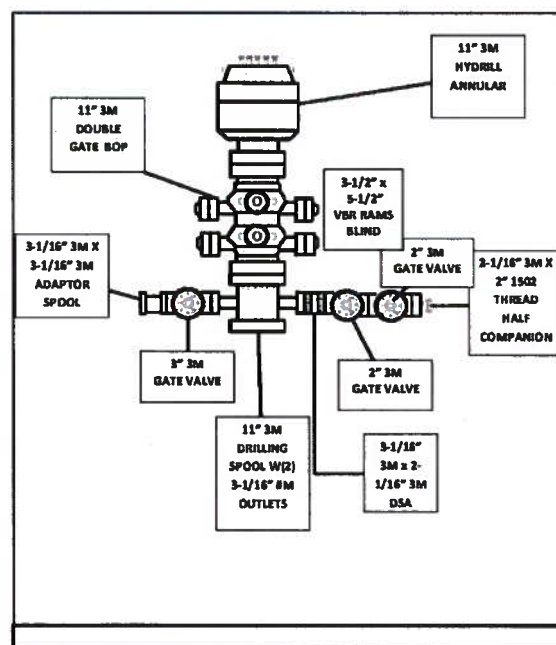

4.4 13-3/8" Conductor

4.4.1 Drilling

The conductor will be installed via auger and grout unless surface conditions dictate driving.

4.4.2 Casing

Set Depth (ft.)	Top (RTE)	Size (in)	Weight (#/ft)	Grade	Burst (psi)	Collapse (psi)	Centralizers
120'	GL	13-3/8	54.5	K-55	2,730	1,130	None

4.5 12-1/4" Surface Hole

4.5.1 Drilling

4.5.1.1 Directional Objective

The surface hole will be drilled vertically to 1,000' MD/TVD.

4.5.1.2 Mud System

The surface hole will be drilled using fresh water based mud. Additives will be included for inhibition and also to build high-viscosity sweeps as necessary.

Measured Depth, ft.	Mud Density, ppg	Funnel Viscosity, cP	Yield Point, lb/100ft ²	API Fluid Loss, ml	pH	LGS %
120 – 1,000'	8.6	25-36	8-12	N/C	7.0-8.0	4 - 7

4.5.2 Open Hole Evaluation

No open-hole evaluation will be conducted in this interval

4.5.3 Casing

The surface casing is to be set at a depth that isolates problematic formations and usable water strata.

Set Depth	Top (RTE)	Size	Weight (#/ft)	Grade	Conn	Internal Diameter	Burst	Collapse	Tension
1,000'	GL	9-5/8"	40.0	K-55	LTC	8.835"	3,950 psi	2,570 psi	561 kips

4.6 8-3/4" Production Hole

The 8-3/4" hole will be drilled directionally to ~5,800'TVD/5,871'MD. Kickoff point will be ~2,500' TVD/MD with a build rate of 2°/100 feet to an angle of 15°. At ~4,490'MD the well will be gradually dropped at 1°/100 feet to total depth. Angle at total depth will be ~2°.

4.6.1 Drilling

4.6.1.1 Directional Objective

The 8-3/4" production hole will be drilled directionally to 5,800' TVD/ 5,871'MD. Surveys will be obtained using a measurement while drilling (MWD) tool.

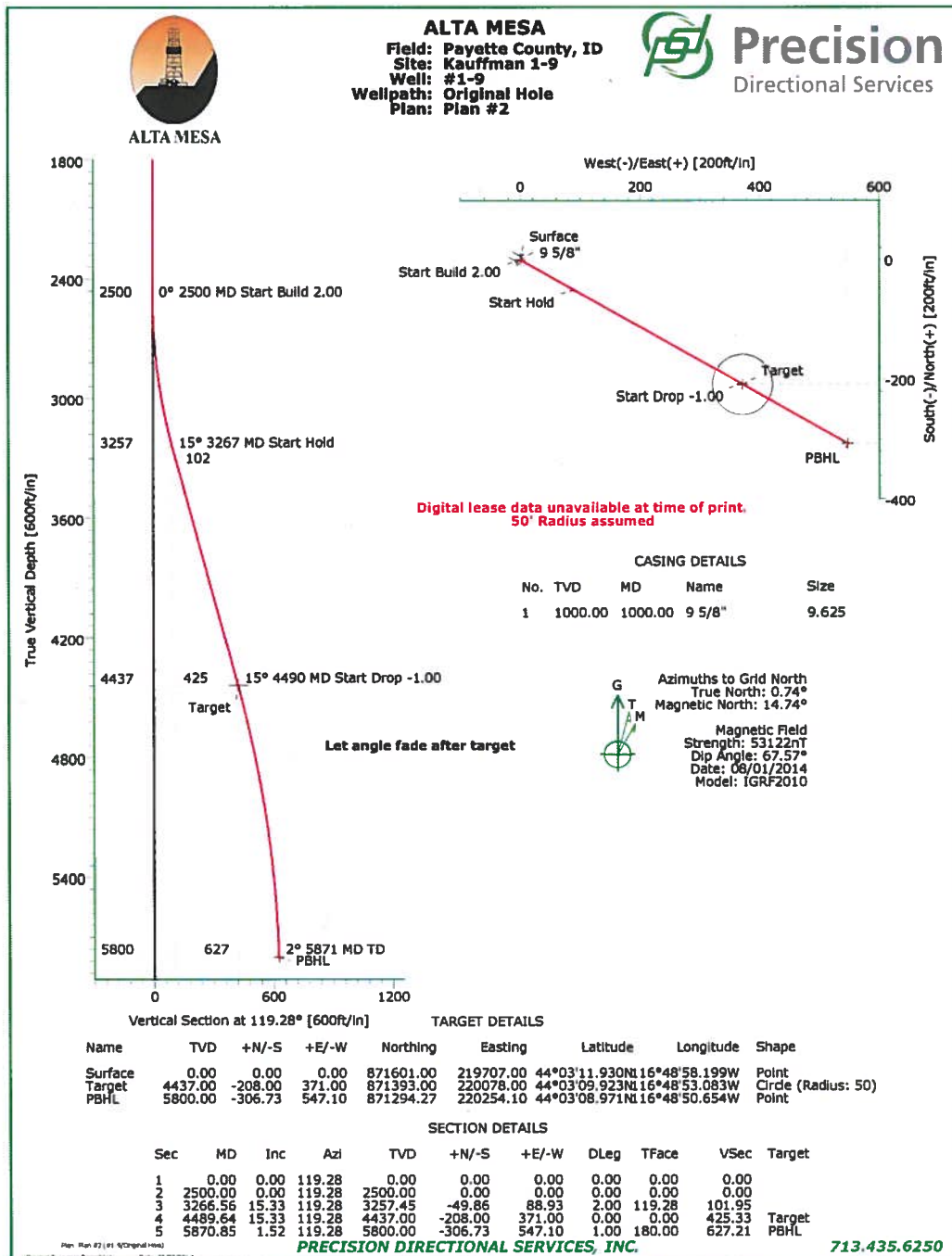

4.6.1.2 Mud System

The production hole interval will be drilled with an invert emulsion mud system.

Measured Depth, ft.	Mud Density, ppg	Funnel Viscosity, cP	Yield Point, lb/100ft ²	HTHP Fluid Loss, ml	ES	LGS %
1,000 – 5,871'	9.2-9.8	36 - 45	6 - 10	<10.0	>600	< 5%

An invert emulsion drilling fluid will be used from below surface casing to total depth. The production casing will be cemented to surface thus, no drilling fluid will be left in the hole. Drill cuttings waste generated will be managed on location by a third party oilfield waste management company who will supervise the solidification, tracking and transportation to an approved waste disposal site of all oilfield waste generated while drilling. A zero-discharge closed loop system will be employed.

4.6.2 Logging Program

While Drilling: Mud logging only

Coring: None

Wireline: After reaching TD, and conditioning the hole, wireline evaluation will be conducted as follows:

- Gamma Ray
- Propagation Resistivity
- Density
- Neutron Porosity
- Electron Capture Spectroscopy
- Sonic
- Percussion sidewall cores

4.6.3 Production Casing

The production casing string is designed to be run to total depth and withstand the expected wellbore pressures.

Set Depth ft.	Top (RTE)	Size	Weight (#/ft)	Grade	Conn.	Internal Diameter	Burst	Collapse	Tension
5,871'	GL	5-1/2"	17	K-55	LTC	4.892"	4,910 psi	5,320 psi	272 kips

5 Completion

Method of completion will be determined subsequent to review of open-hole log data and cased hole cement bond logs (CBL).

6 Wellhead

6.1 Surface Wellhead System

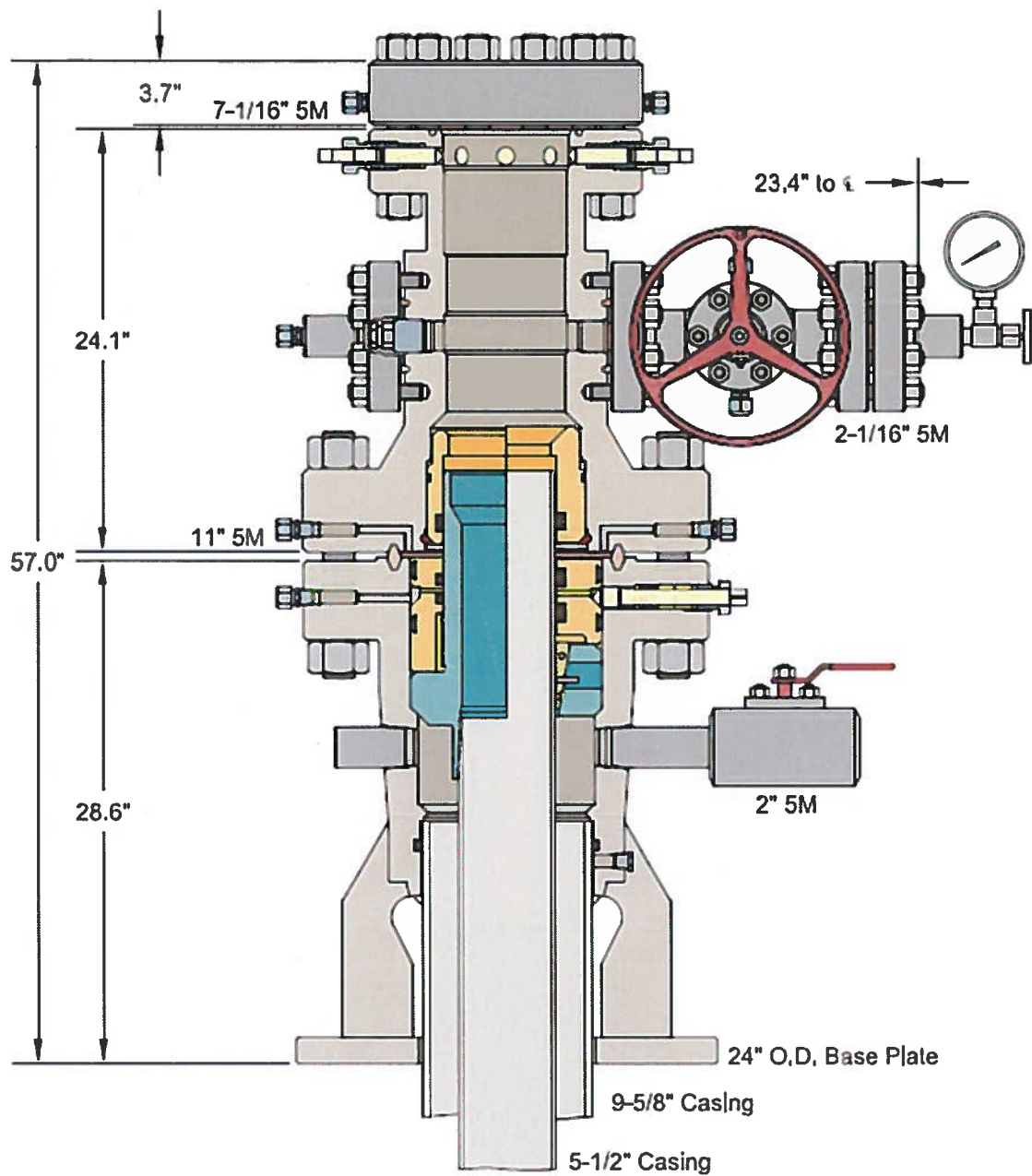

6.2 Complete Wellhead System with Tree

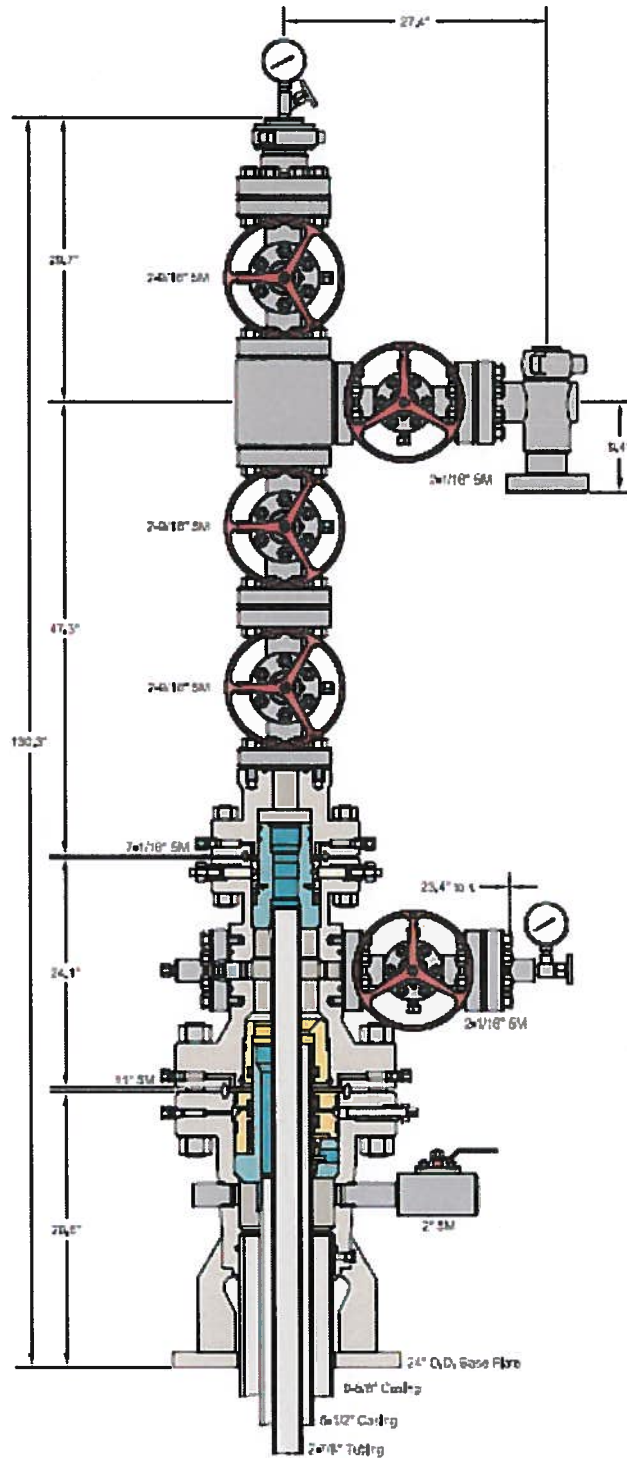

7 Reclamation

Reclamation will be conducted in accordance with IDAPA 20.07.02.325. To achieve those requirements, Alta Mesa Services, L.P. proposes to address reclamation through a multistep process which is outlined below. As provided for in IDAPA 20.07.02.325.08, Alta Mesa Services, L.P. may enter into a Surface Use Agreement with the landowner the terms of which will ensure that the site is left in a stable, non-eroding condition as required.

1. Re-establish slope stability, surface stability, and desired topographic diversity.
 - a. Reconstruct the landscape to the approximate original contour unless otherwise provided for in the Surface Use Agreement
 - b. Maximize geomorphic stability and topographic diversity of the reclaimed topography.
 - c. Eliminate high walls, cut slopes, and/or topographic depressions on site, unless otherwise approved.
 - d. Minimize sheet and rill erosion on the reclaimed area. Eliminate mass wasting, head cutting, large rills or gullies, down cutting in drainages, or overall slope instability on the reclaimed area.
2. Maintain the integrity of the topsoil and subsoil (where appropriate and not otherwise dictated by the Surface Use Agreement)
 - a. Identify salvaged topsoil and subsoil.
 - b. Segregation of salvaged soils to protect those materials from erosion, degradation, and contamination.
 - c. Incorporate stored soil material into the disturbed landscape to the extent practicable.
 - d. Stockpiled soils to be stored beyond one growing season shall be stabilized with appropriate vegetation
 - e. Record location and approximate volumes of stockpiles.
3. Prepare site for revegetation upon completion of well activities – plugging/abandonment.
 - a. Redistribute soil materials in a manner similar to the original vertical profile.
 - b. Reduce compaction to an appropriate depth (generally below the root zone) prior to redistribution of topsoil, to accommodate appropriate site-specific plant species.
 - c. Provide suitable conditions to support the long term establishment and viability of the desired plant community.
 - d. Protect seed and seedling establishment (e.g. erosion control matting, mulching, hydro-seeding, surface roughening, fencing, etc. to be determined based upon site specific conditions
4. Establish a desired self-perpetuating native plant community based upon region specific guidance available from NRCS
 - a. Establish species composition, diversity, structure, and total ground cover appropriate for the desired plant community
 - b. Select genetically appropriate and locally adapted native plant materials based on the site characteristics and setting.
 - i. Seed mixtures shall be selected based on soil type, site conditions and intended final use
 - ii. Seed shall not be used later than one year after the test date that appears on the label.
 - iii. The bags of seed shall be clearly labeled indicating test date, weed percentage or % Pure Live Seed (PLS), viability or germination percentage, and inert material

- c. Select non-native plants only as a short term and non-persistent alternative to native plant materials. Ensure the non-natives are designed to aid in the re-establishment of native plant communities. Revegetate in accordance with best practices described below:
 - i. Re-spread topsoil to a minimum depth of 4 inches.
 - ii. Prepare a friable but firm and weed free seedbed that is not compacted by prior construction work.
 - iii. Appropriate firmness can be estimated when a person leaves about a ¼ inch deep footprint.
 - iv. Remove rocks, twigs, concrete, foreign material and clods over 2 inches that can't be broken down.
 - v. Soil moisture content shall be at least 30% soil capacity (estimated). Do not seed into undesirable moisture conditions (e.g. "dust" or "mud").
 - d. Plant communities shall be evaluated annually for two years to ensure revegetation success as determined by IDAPA 20.07.02.325
 - i. Repair and reseed areas that have erosion damage as necessary.
 - ii. If a stand has less than 70% ground cover after two years, re-evaluate the choice of plant materials, methods and available light and moisture. Re-establish the stand with modifications based on the evaluation
5. Reestablish initial visual composition
- a. Ensure the reclaimed landscape features conform to the prior conditions of the site.



PERKINS PEISERICH GREATHOUSE MORGAN RANKIN

101 MORGAN KEEGAN DRIVE, SUITE A | LITTLE ROCK, AR 72202
P.O. BOX 251618 | LITTLE ROCK, AR 72225-1618
TEL: (501) 603-9000 | FAX: (501) 603-0556 | PPGMRLAW.COM | PLLC

JOHN F. PEISERICH
JOHN@PPGMRLAW.COM

July 19, 2013

Mr. Bobby Johnson
Idaho Department of Lands
Idaho Oil and Gas Conservation Commission
300 N. 6th Street
Suite 103
Boise, ID 83702

RE: Exceptional Location Letter Application
Section 9, Township 8 North, Range 4 West
Willow Field, Payette County, Idaho

Mr. Johnson,

Please allow this letter to serve as Alta Mesa Services, LP's application for an exceptional location for its well proposed in Section 9, Township 8 North, Range 4 West in the Willow Field located in Payette County, Idaho. The well permit application is being transmitted concurrently for your consideration and Alta Mesa Services, LP ("Applicant") requests that this letter application be attached to the well permit as an additional submittal.

In accordance with IDAPA 20.07.02.330.04, the Applicant submits with this application a plat which provides the following information:

- a. The location at which an oil or gas well could be drilled in compliance with Subsections 330.01 or 330.02 or the applicable order;
(demonstrated as the nearest potential well location within Section 4)
- b. The location at which the applicant requests permission to drill; and
(demonstrated by the Proposed Well Location)
- c. The location at which oil or gas wells have been drilled or could be drilled, in agreement with Subsection 330.01 or 330.02 or the applicable order, directly or diagonally offsetting the proposed exception. *(In Section 10, the ML Investments No. 1-10 is indicated in the north-central portion of the section. Also in Section 10, the ML Investments No. 2-10 is indicated in the northeast portion of the section. Each of these locations are well beyond the expected potential drainage zone of the proposed wells. The drainage zone is indicated on the attached plat and potential locations are demonstrated by the 1,660 foot legal location boxes shown within each section.)*

It should be noted that AM Idaho, LLC is the only working interest owner in the offset sections and thus would be operator in each of those sections.

The Applicant, Alta Mesa Services, LP, requests the approval of an exceptional location due to surface and reservoir characteristics related to the target formation. The proposed surface hole and bottom hole locations are the most protective of the environment; are the most prospective for oil and/or gas; and are necessary to prevent waste and avoid stranding of resources.

The target formation presents the optimal drilling target at the location selected by the Applicant. Specifically, three dimensional seismic survey data has identified the target, identified for discussion purposes as the "Willow Sand", as time equivalent to the Willow Sand found in the ML Investment #1-10 well. Seismic data of the target indicates [REDACTED] i.e. a likely indicator of high-hydrocarbon saturation. The reservoir appears to be [REDACTED] with a [REDACTED] the boundary between [REDACTED] with the vast majority located in [REDACTED]. Generally, the existing identified reservoirs in Section 10 are fault separated from Section 9 as a significant fault runs [REDACTED] of the proposed well in Section 9 and [REDACTED] of the existing well location in Section 10.

Geologically, the selected target is believed to be the best potential location within the reservoir with the greatest chance that the target will be prospective for oil and/or gas. Selection of this location will reduce the number of wells necessary to fully develop the prospect by selecting the target with the greatest drainage potential which will prevent economic waste; prevent drilling of additional otherwise unnecessary wells which causes additional surface impacts; and avoid creating areas within the reservoir that are incapable of being drained.

For the reasons stated above, Alta Mesa Services, LP respectfully requests the approval of this exceptional location. If you have further questions, please contact me.

Sincerely,

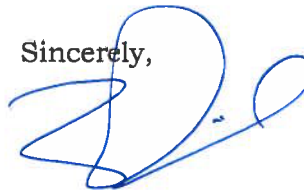

John F. Peiserich



PERKINS PEISERICH GREATHOUSE MORGAN RANKIN

101 MORGAN KEEGAN DRIVE, SUITE A | LITTLE ROCK, AR 72202
P.O. BOX 251618 | LITTLE ROCK, AR 72225-1618
TEL: (501) 603-9000 | FAX: (501) 603-0556 | PPGMRLAW.COM | PLLC

JOHN F. PEISERICH
JOHN@PPGMRLAW.COM

July 19, 2013

Mr. Bobby Johnson
Idaho Department of Lands
Idaho Oil and Gas Conservation Commission
300 N. 6th Street, Suite 103
Boise, ID 83702

RE: Direction Deviation Letter Application
Section 9, Township 8 North, Range 4 West
Willow Field, Payette County, Idaho

Mr. Johnson,

Please allow this letter to serve as Alta Mesa Services, LP's application for a deviation from vertical for its well proposed in Section 9, Township 8 North, Range 4 West in the Willow Field located in Payette County, Idaho. The well permit application is being transmitted concurrently for your consideration and Alta Mesa Services, LP ("Applicant") requests that this letter application be attached to the well permit as an additional submittal. The well permit application previously submitted includes the information regarding the surface and bottom hole locations along with the planned well path from the directional contractor.

The proposed deviation is requested due to the topographic conditions present at the surface immediately above the bottom hole location. The topography is extremely rugged, composed of a steep hillside that would require extensive excavation that, even with such excavation, may not provide a safe working environment. In addition to ensuring a safe working environment, the Applicant also seeks to minimize the surface impacts by reducing amount of excavating required.

It should be noted that AM Idaho, LLC is the only working interest owner in the offset sections and thus would be operator in each of those sections. As such, no notice to the offset operator is provided.

If you have any questions regarding this application for deviation from vertical, please contact me.

Sincerely,

A handwritten signature in black ink, appearing to read 'JLR', is written over a light blue horizontal line.

John Peiserich

AM IDAHO Kaufmann # 1-9

Time Structure Map of Top Willow Sand

(North-South Seismic line in RED)

CONFIDENTIAL

N-S Seismic Line thru proposed
Kaufmann #1-9, (North on left)

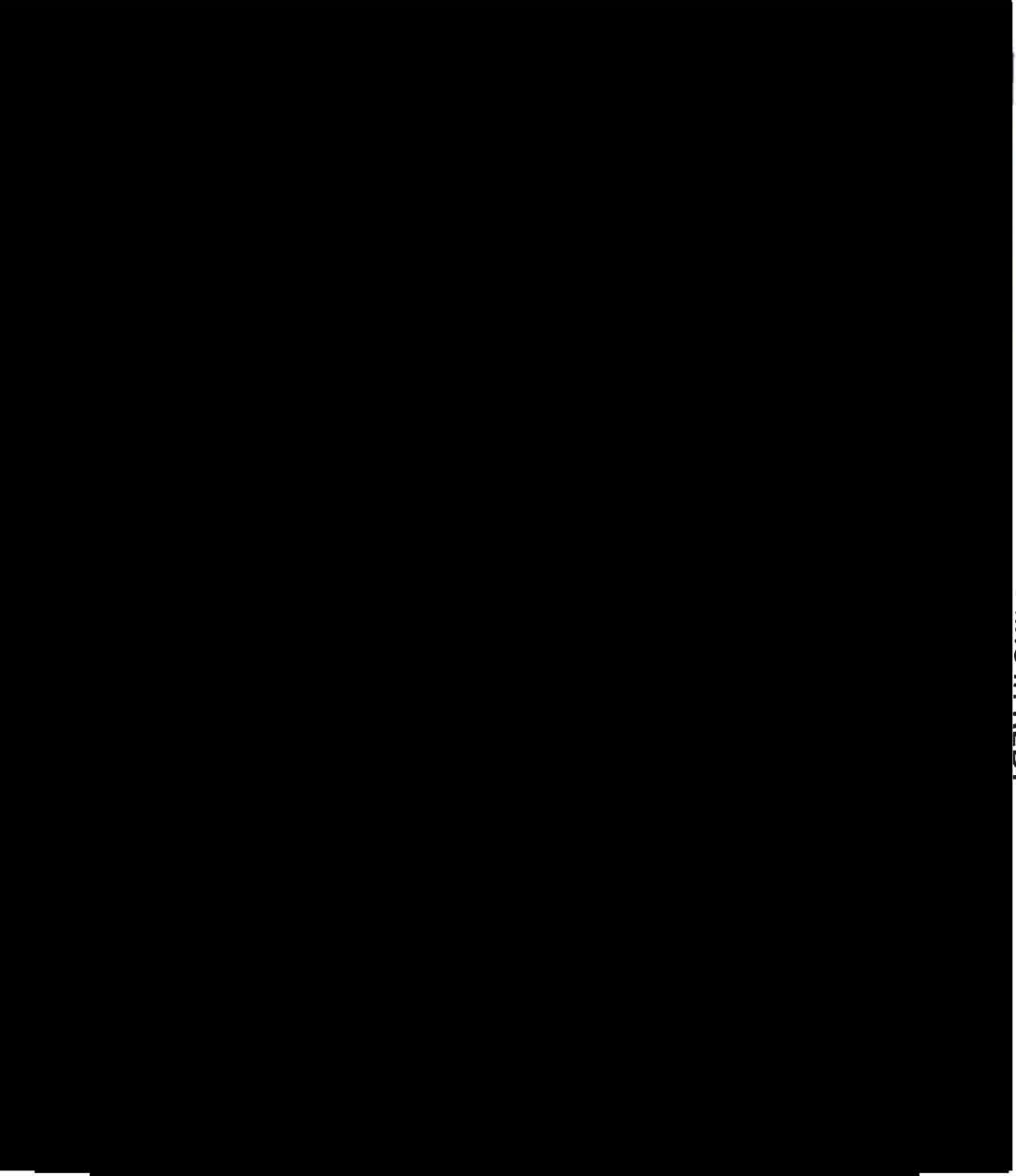

**TRADE SECRET PROTECTED
UNDER IDAHO CODE Title 9,
Chapter 3, 9-340D**

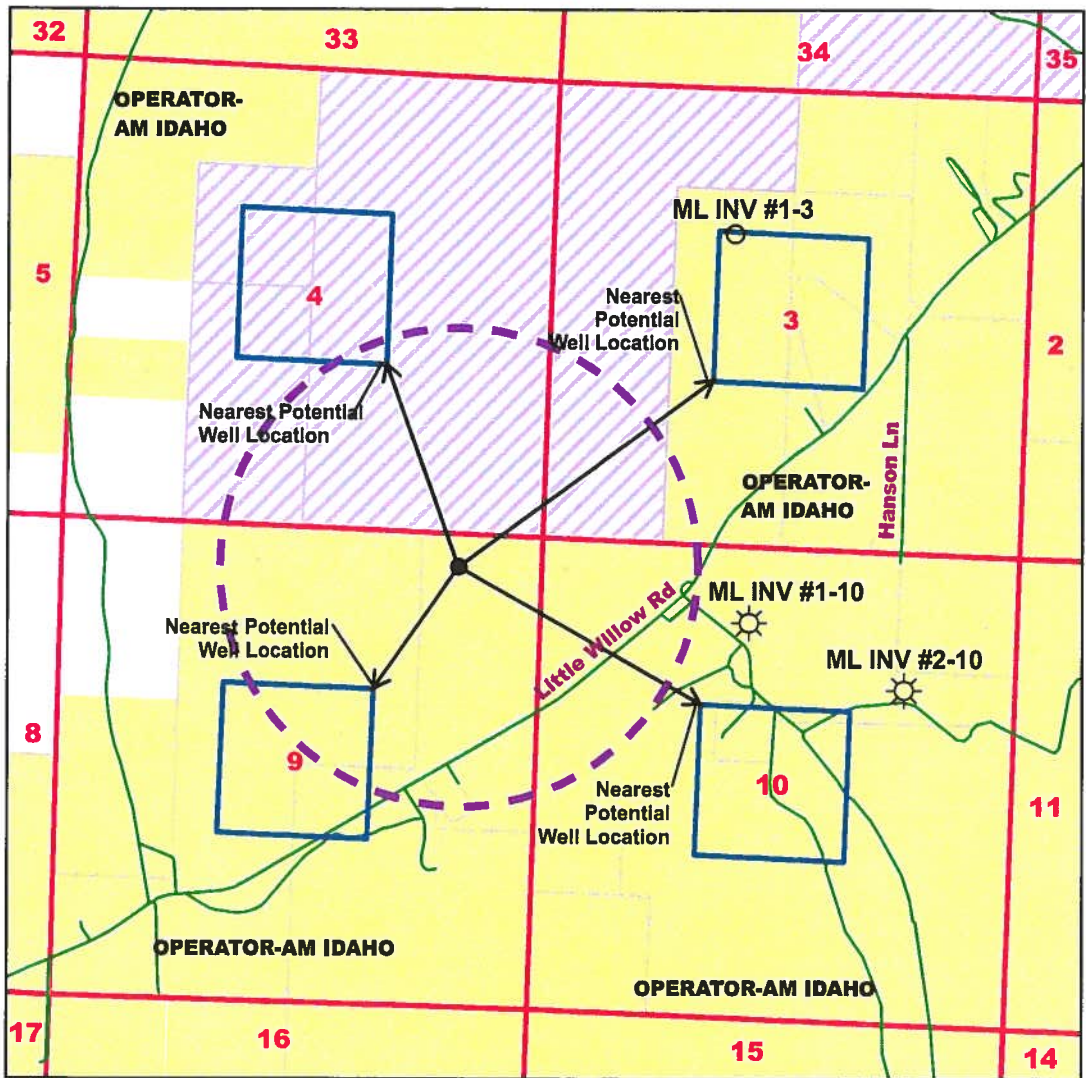

Kauffman 1-9

Located in Section 9, T8N R4W, BM, Payette County, ID
05/28/14

Legend

- Legal Location
- - - Anticipated Well Drainage Zone (1 Mile Diameter Circle)
- Section Lines
- Roadways
- Property Boundary
- AM Idaho
- BLM owns mineral rights only
- Proposed Bottom Hole Well Location

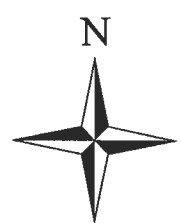

1 inch equals 2,000 feet